

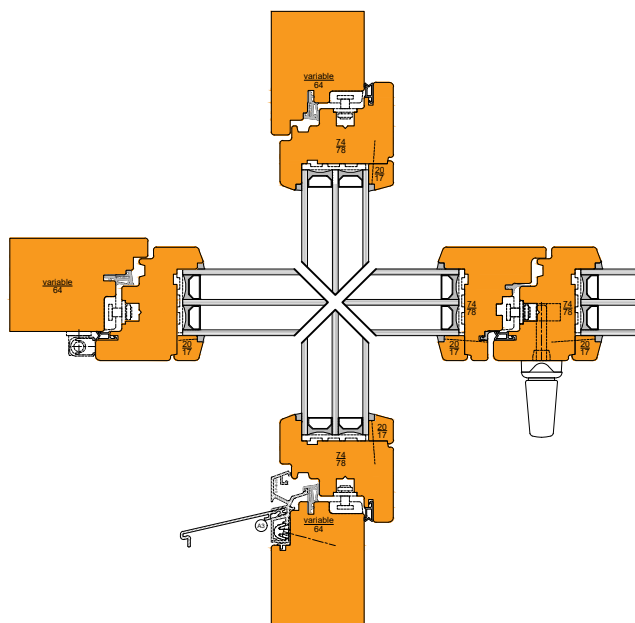

# FENÊTRE BOIS 64/78

## SIRIUS V - SiB 64/78

Coupe Haut/Bas - Standard	p.1
Plan Latéral - Standard	p.2
Plan Médian - Standard	p.3
Plan Médian - Poignée traversante	p.4
Coupe Médiane - Fixe + Ouvrant	p.5
Coupe Haut/Bas - Vitrage Fixe	p.6
Plan latéral - Vitrage Fixe	p.7
Plan latéral - Poignée espagnolette	p.8
Plan Médian - Poignée espagnolette	p.9
Croisillons Contemporain	p.10
Croisillons - rapportés à l'extérieur	p.11



 Gindraux Fenêtres	Bois_SiB-6478-Site		
	Table des matières		
Echelle: 1/1	POSITION:	NBRE(S) DE PIECE(S):	
Date de création: 18-janv.-22	Sous réserve de modifications pour adaptation au progrès technique		
Date d'impression: 31-mars-22	c:\users\ralsina\Desktop\presentation site\dwg site\bois_sib-6478-site		Date: Visa d'approbation:

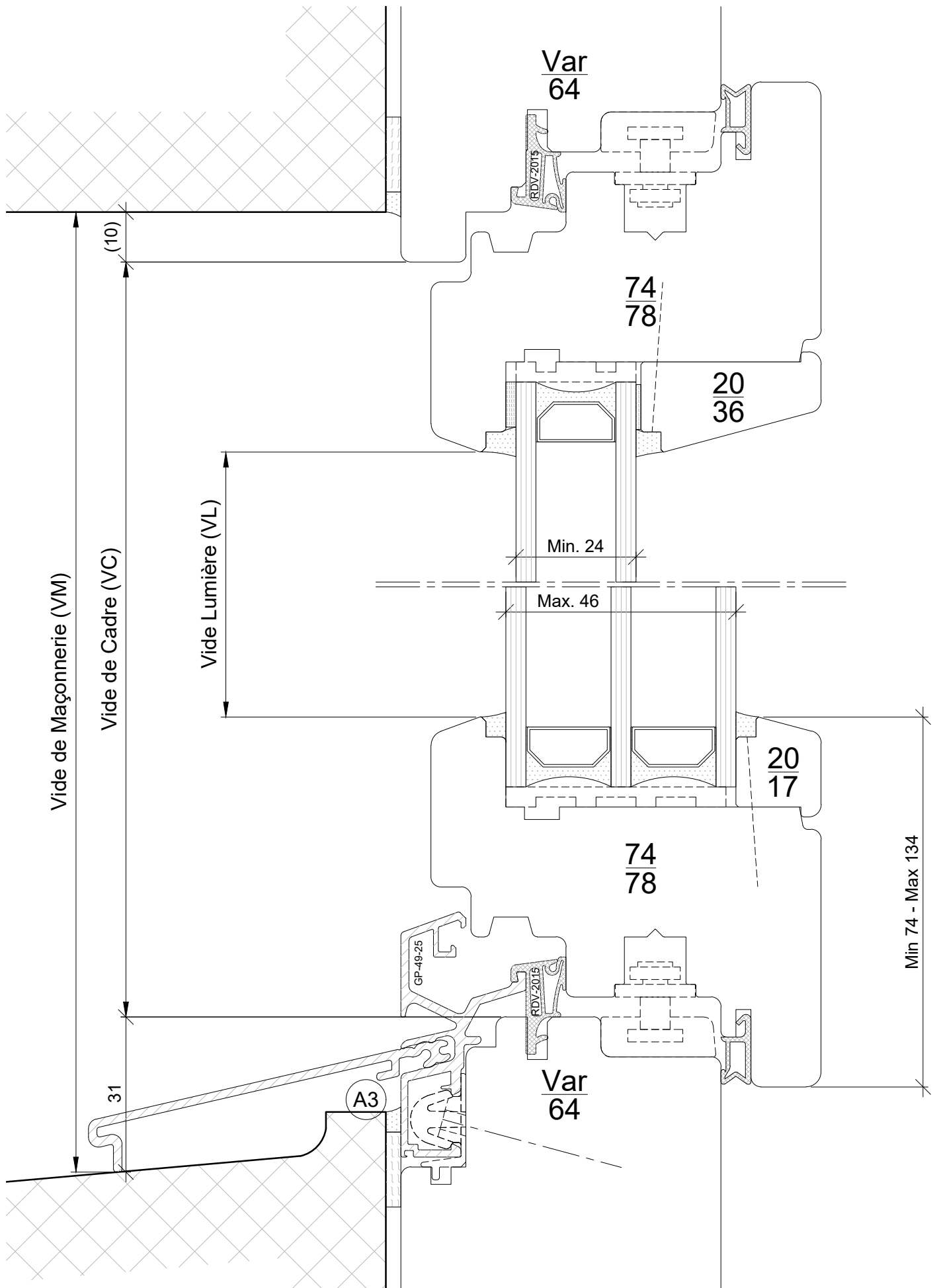

Bois\_SiB-6478-Site



Coupe Standard – Haut/Bas

Echelle: 1/1

POSITION: p.1 NBRE(S) DE PIECE(S):

Date de création: 18-janv.-22

Sous réserve de modifications pour adaptation au progrès technique

Date d'impression: 31-mars-22

c:\users\ralsina\Desktop\presentation\_site\dwg\_site\bois\_sib-6478-site

Date:

Visa d'approbation:

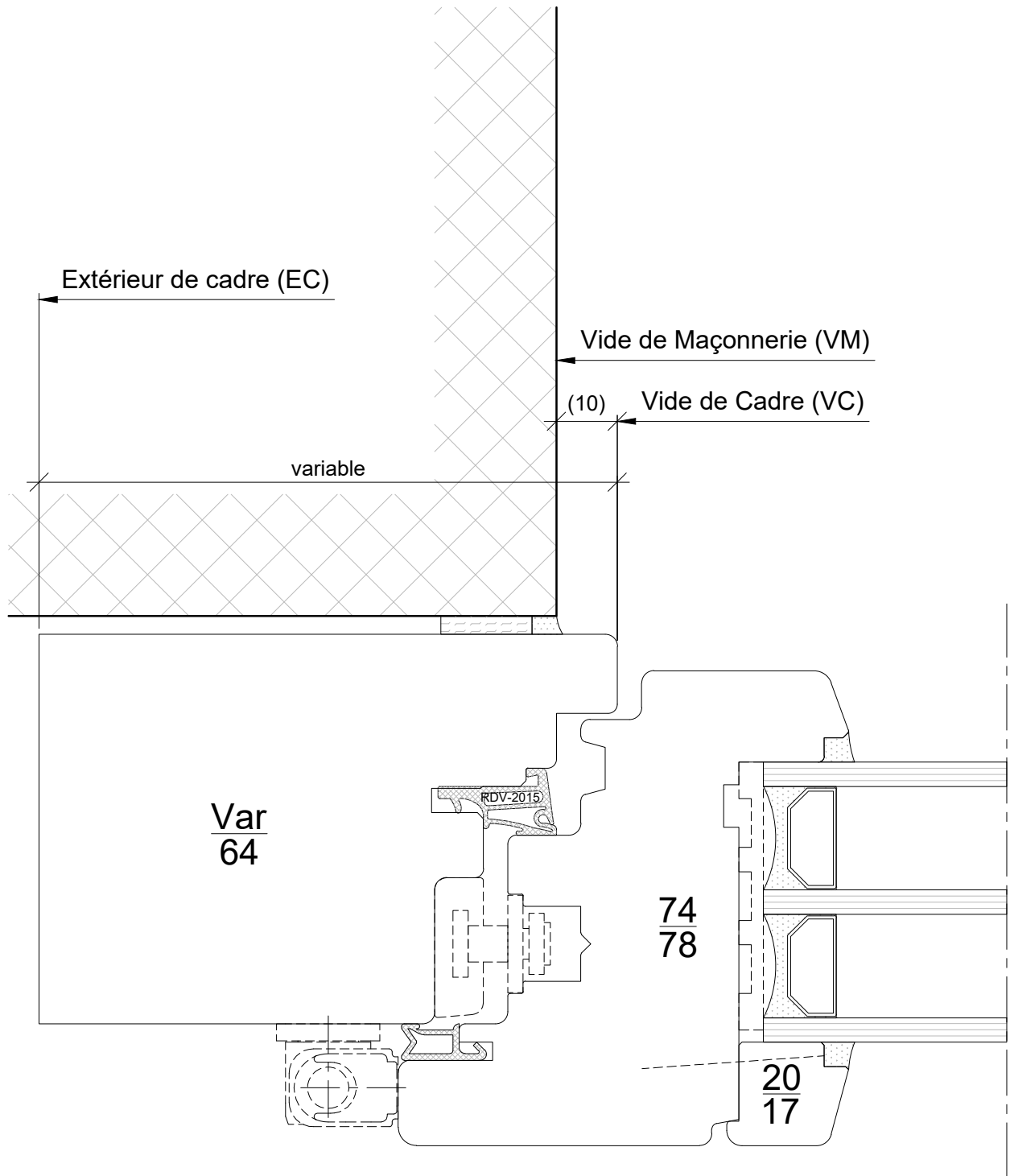

 <b>Gindraux Fenêtres</b>	<b>Bois_SiB-6478-Site</b>		
	Plan Latéral – Standard		
Echelle: 1/1	POSITION: p.2	NBRE(S) DE PIECE(S):	
Date de création: 18-janv.-22	Sous réserve de modifications pour adaptation au progrès technique		
Date d'impression: 31-mars-22	c:\users\ralsina\Desktop\presentation site\dwg site\bois_sib-6478-site		Date: Visa d'approbation:

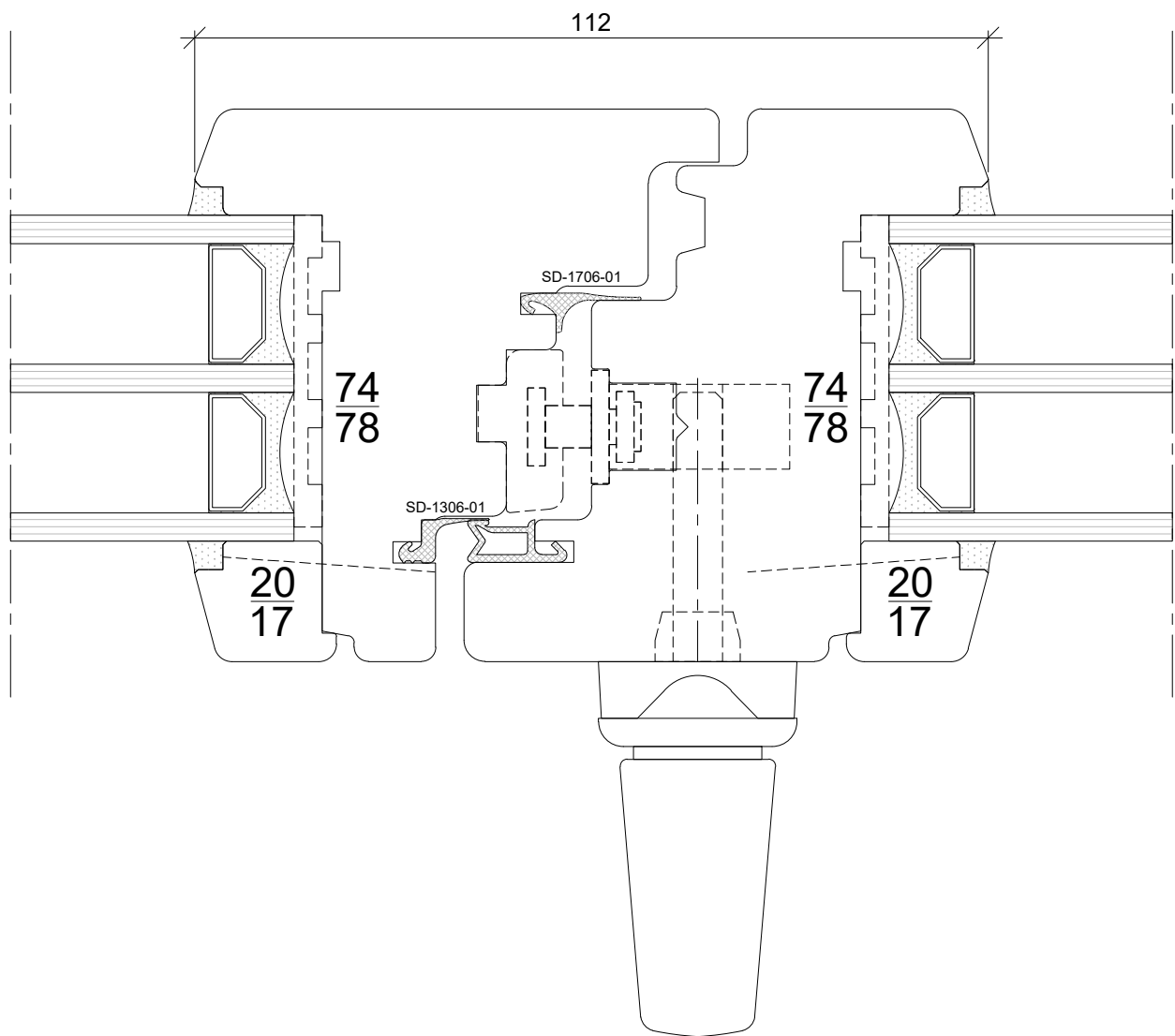

 <b>Gindraux Fenêtres</b>	<b>Bois_SiB-6478-Site</b>		
	<b>Plan Médian – Standard</b>		
Echelle: 1/1	POSITION: p.3      NBRE(S) DE PIECE(S):		
Date de création: 18-janv.-22	Sous réserve de modifications pour adaptation au progrès technique		
Date d'impression: 31-mars-22	<small>c:\users\ralsina\Desktop\presentation site\dwg site\bois_sib-6478-site</small>		Date:      Visa d'approbation:

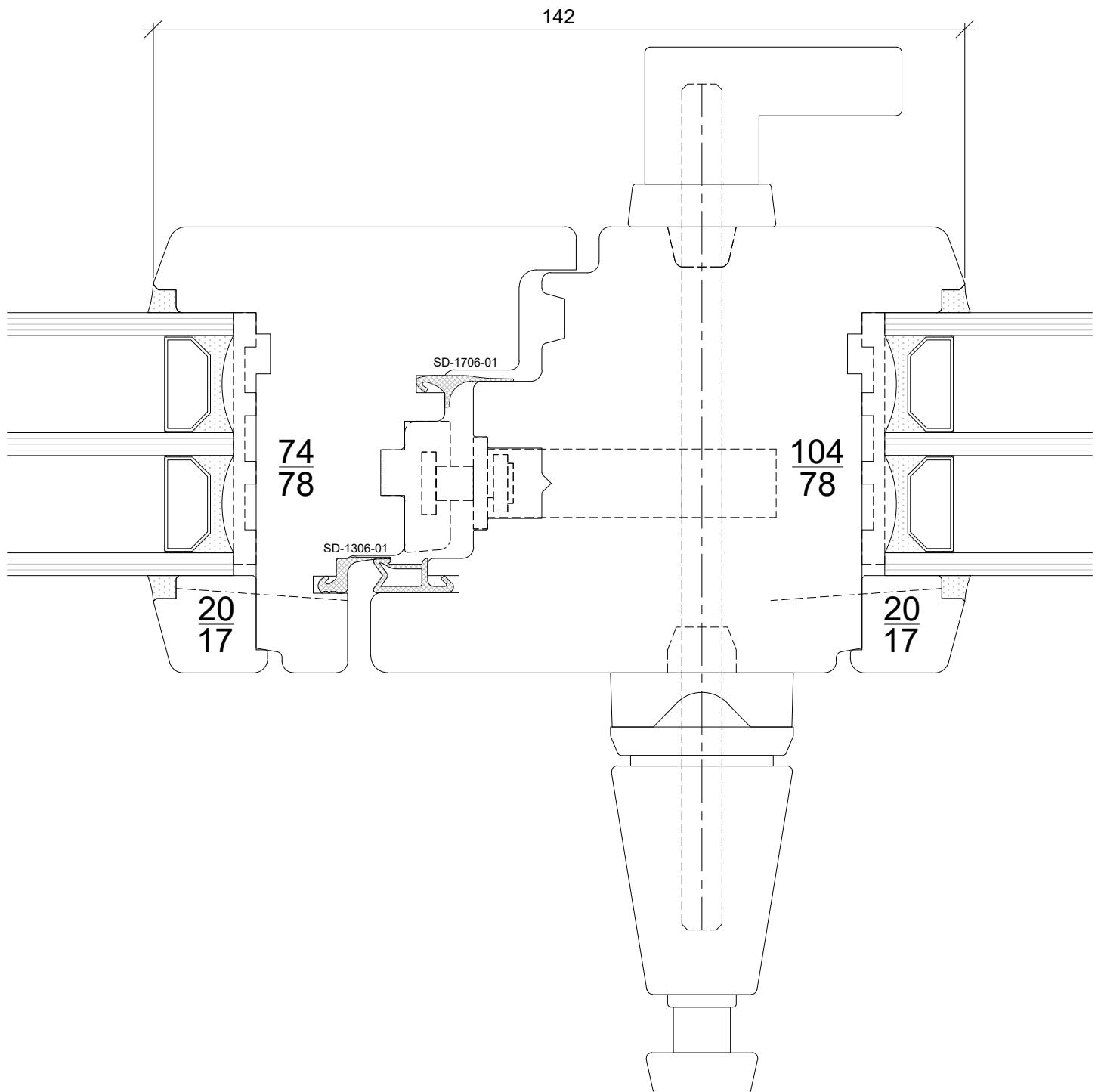

 <b>Gindraux Fenêtres</b>	<b>Bois_SiB-6478-Site</b>		
	Plan Médian – Poignée traversante POSITION: p.4      NBRE(S) DE PIECE(S):		
Echelle: 1/1	18-janv.-22	Sous réserve de modifications pour adaptation au progrès technique	Date:
Date de création:	31-mars-22	c:\users\ralsina\Desktop\presentation site\dwg site\bois_sib-6478-site	Visa d'approbation:

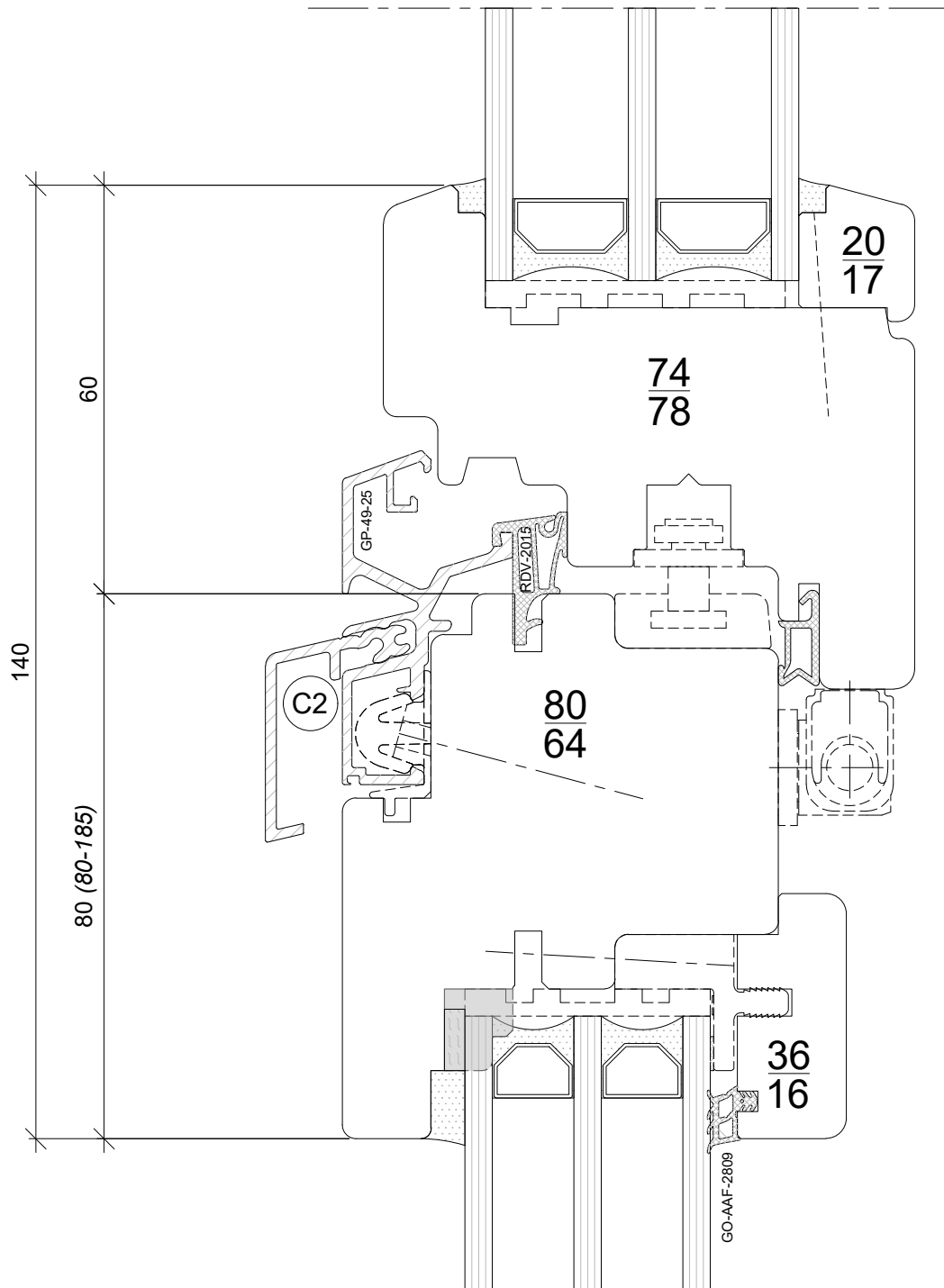

 Gindraux Fenêtres	Bois_SiB-6478-Site		Coupe Médiane – Fixe+Ouvrant POSITION:p.5      NBRE(S) DE PIECE(S):
	Echelle: 1/1		
Date de création:	18-janv.-22	Sous réserve de modifications pour adaptation au progrès technique	
Date d'impression:	31-mars-22	c:\users\ralsina\Desktop\presentation site\dwg site\bois_sib-6478-site	
			Date:      Visa d'approbation:

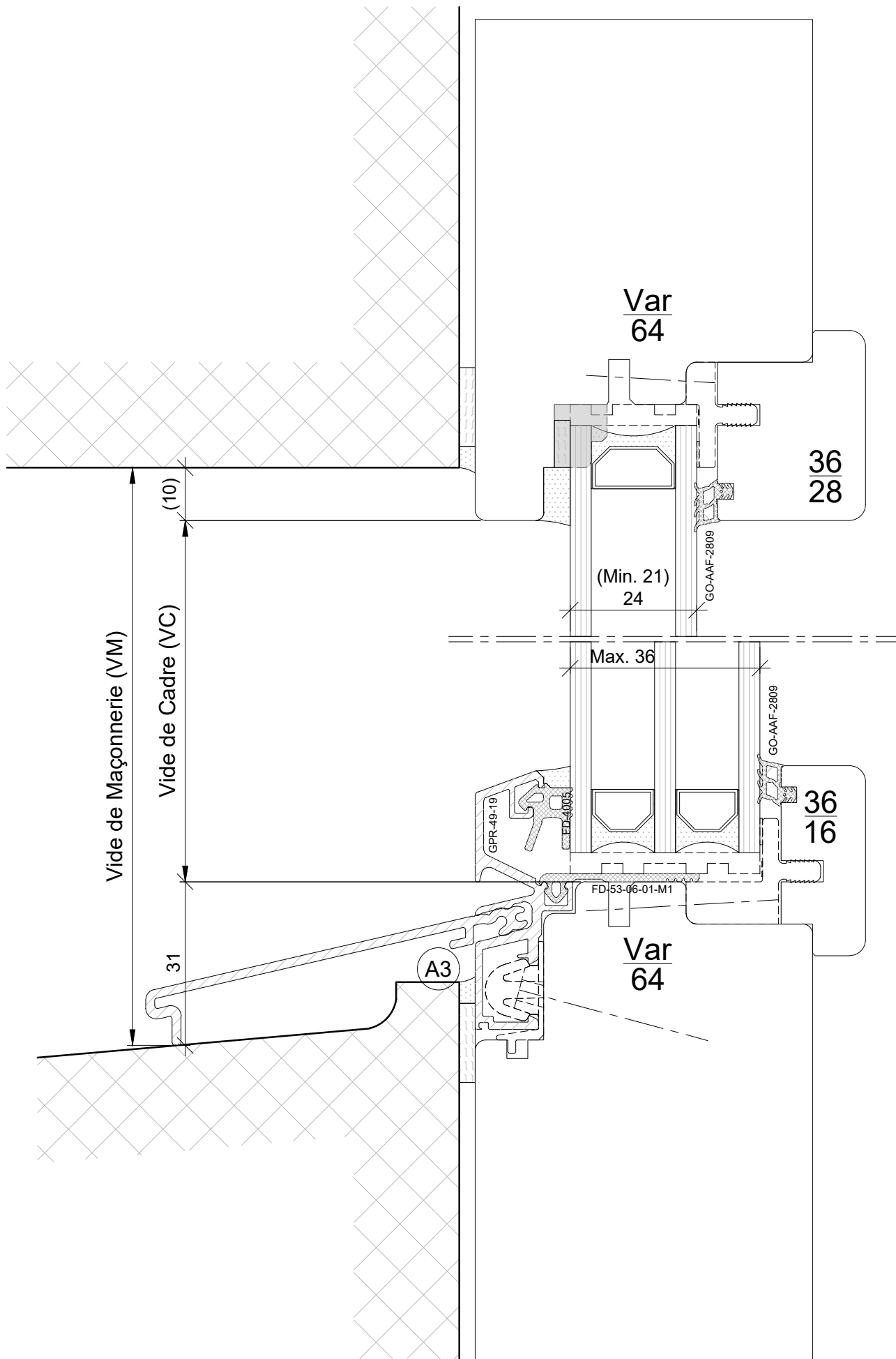

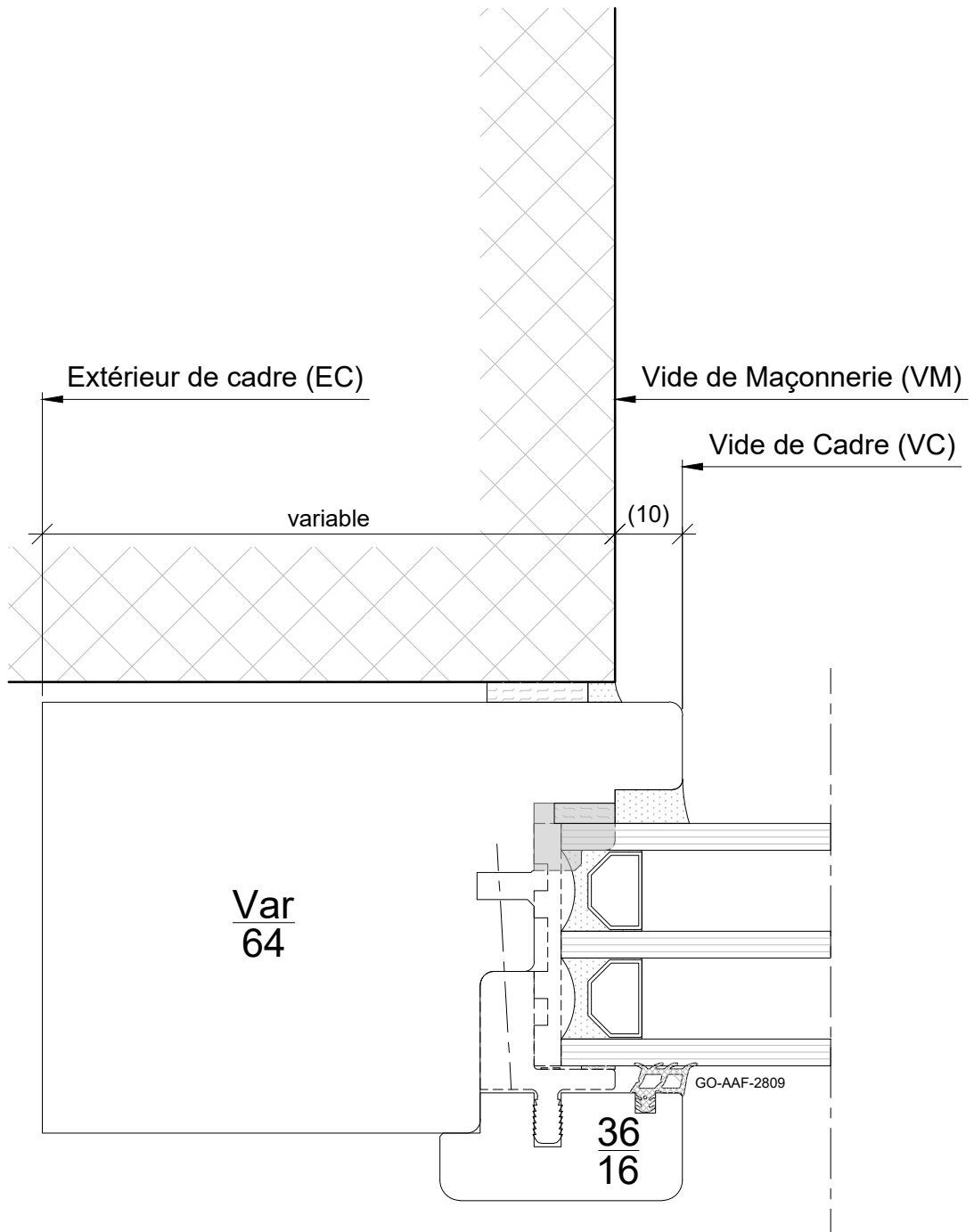

 Gindraux Fenêtres	Bois_SiB-6478-Site		
	Coupe Haut/Bas – Vitrage Fixe		
Echelle: 1/1	POSITION: p.6	NBRE(S) DE PIECE(S):	
Date de création: 18-janv.-22	Sous réserve de modifications pour adaptation au progrès technique		
Date d'impression: 31-mars-22	c:\users\ralsina\Desktop\presentation_site\dwg_site\bois_sib-6478-site		Date: Visa d'approbation:



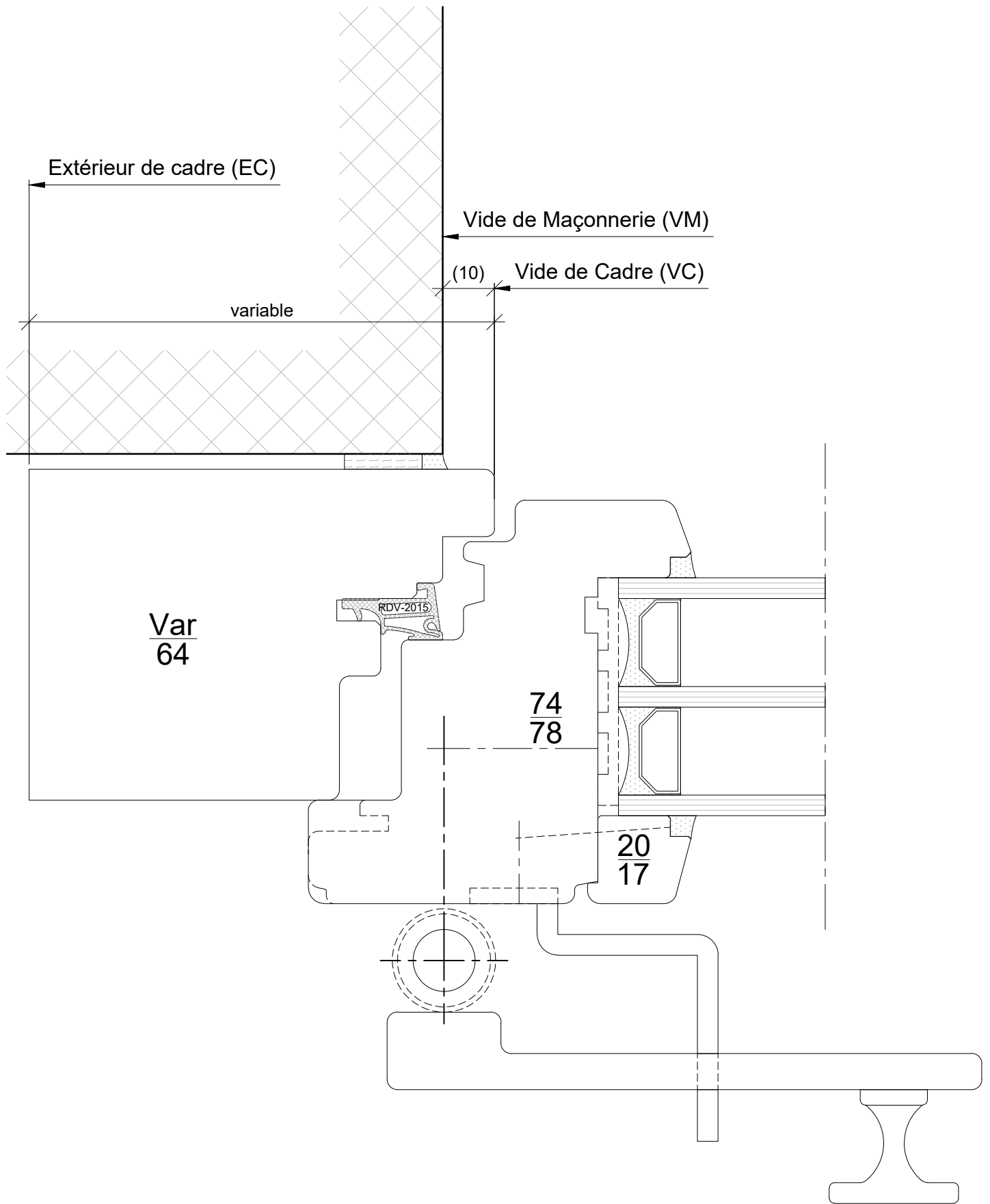

 Gindraux Fenêtres	Bois_SiB-6478-Site		Plan Médian – Vitrage Fixe POSITION: p.7      NBRE(S) DE PIECE(S):	
	Echelle: 1/1			
Date de création:	18-janv.-22	Sous réserve de modifications pour adaptation au progrès technique		Date:      Visa d'approbation:
Date d'impression:	31-mars-22	c:\users\ralsina\Desktop\presentation site\dwg site\bois_sib-6478-site		



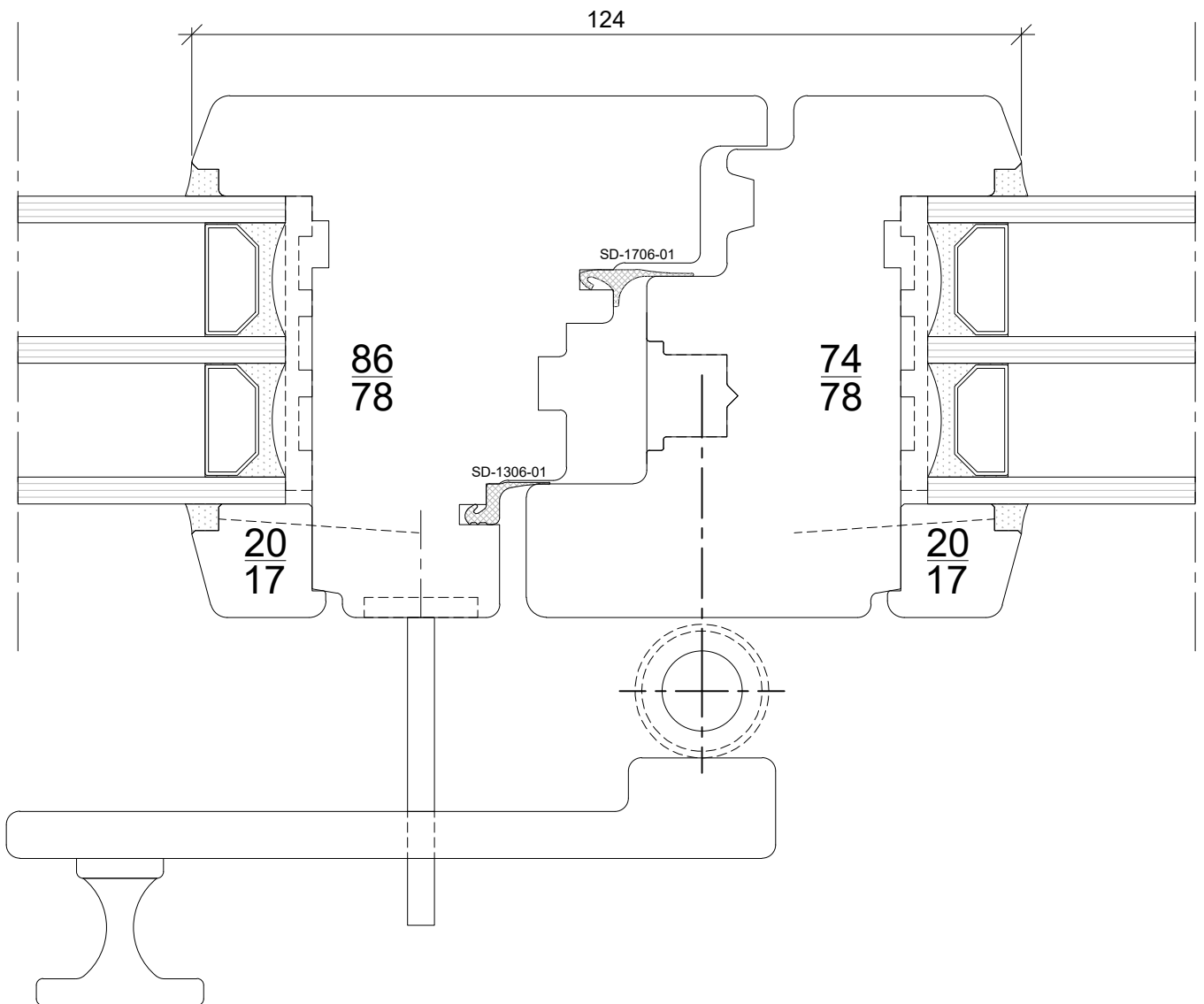

 Gindraux Fenêtres	Bois_SiB-6478-Site		
	Plan Latéral – Poignée espagnolette		
Echelle: 1/1	POSITION: p.8      NBRE(S) DE PIECE(S):		
Date de création: 18-janv.-22	Sous réserve de modifications pour adaptation au progrès technique		
Date d'impression: 31-mars-22	c:\users\ralsina\Desktop\presentation site\dwg site\bois_sib-6478-site		Date:      Visa d'approbation:



 <b>Gindraux Fenêtres</b>	<b>Bois_SiB-6478-Site</b>		
	Plan Médian – Poignée espagnolette		
Echelle: 1/1	POSITION:p.9      NBRE(S) DE PIECE(S):		
Date de création:	18-janv.-22	Sous réserve de modifications pour adaptation au progrès technique	
Date d'impression:	31-mars-22	c:\users\ralsina\Desktop\presentation site\dwg site\bois_sib-6478-site	
			Date:      Visa d'approbation:

### Landhaus contemporain

Uniquement pour intercalaire

- 12mm
- 14mm
- 15mm
- 16mm

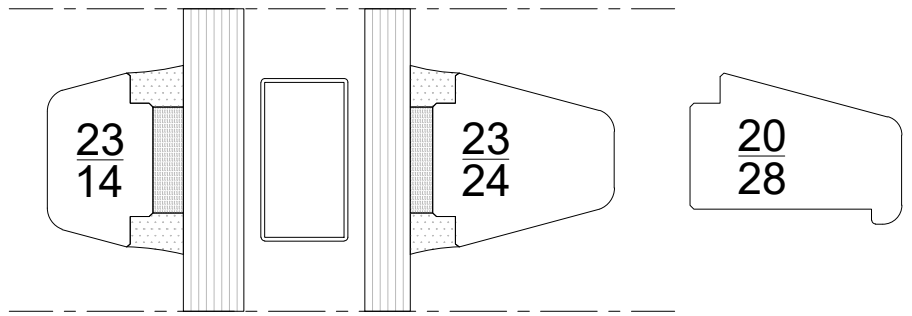

### Landhaus disponible

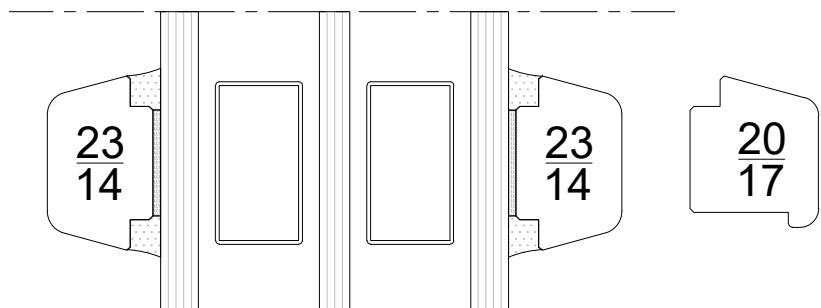
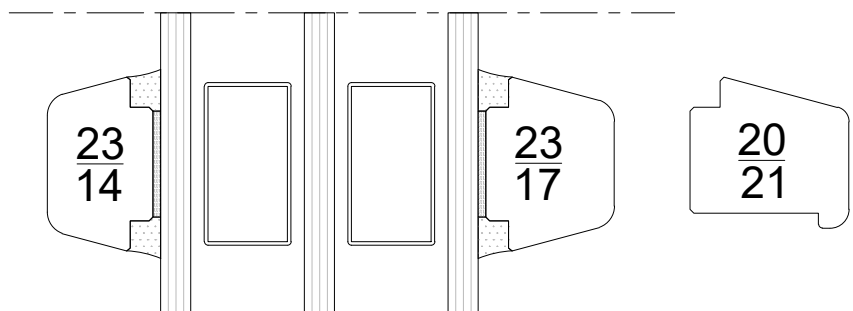
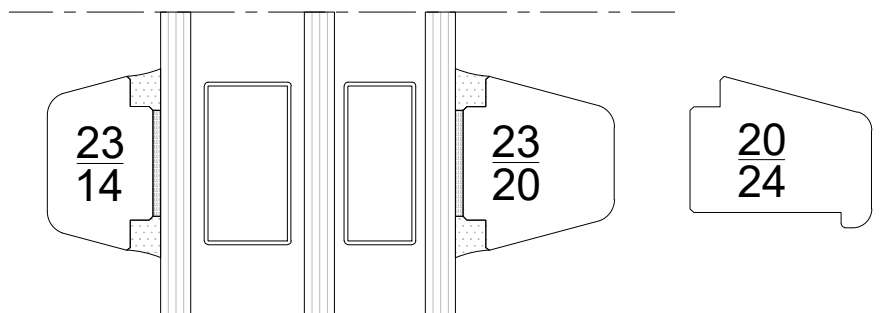
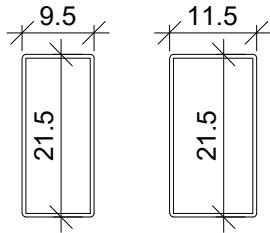

 Gindraux Fenêtres	Bois_SiB-6478-Site		Croisillons – contemporain POSITION: p.10    NBRE(S) DE PIECE(S):	Date:                      Visa d'approbation:
	Echelle: 1/1	18-janv.-22		
Date de création:	31-mars-22	c:\users\ralsina\Desktop\presentation site\dwg site\bois_sib-6478-site		
Date d'impression:				

