

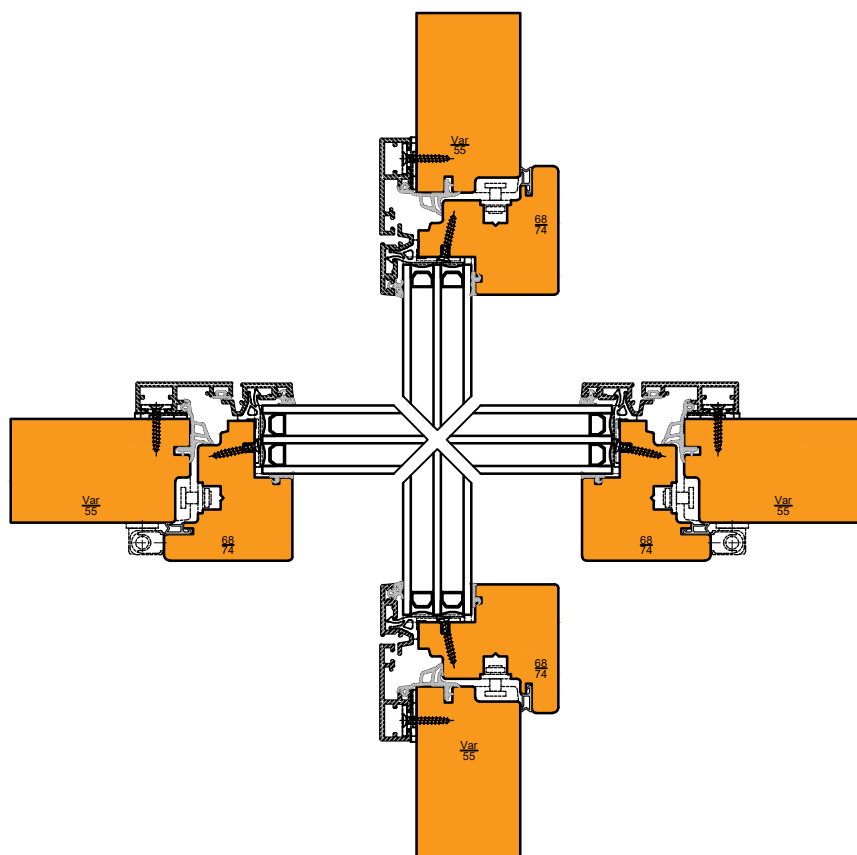

FENÊTRE BOIS METAL 55/74

SIRIUS V SiFA 55/74

Coupe Haut/Bas - Standard	p.1
Plan Latéral - Standard	p.2
Plan Médian - Standard	p.3
Plan Médian - Poignée Transversale	p.4
Plan Médian - Fixe + Ouvrant	p.5
Coupe Médiane - Fixe + Ouvrant	p.6
Coupe Haut/Bas - Vitrage Fixe	p.7
Coupe Latéral - Vitrage Fixe	p.8
Coupe Haut/Bas - Vitrage extérieur	p.9
Coupe Médiane - Vitrage Extérieur	p.10
Plan Latéral - Vitrage Extérieur	p.11



	SiFA-5574		
	Echelle:	POSITION: NBRE(S) DE PIECE(S):	
Date de création:	14-janv.-22	Sous réserve de modifications pour adaptation au progrès technique	Date: Visa d'approbation:
Date d'impression:	28-mars-22	c:\users\roland\Desktop\presentation clienta\alfa-5574 (ok)\alfa-5574	

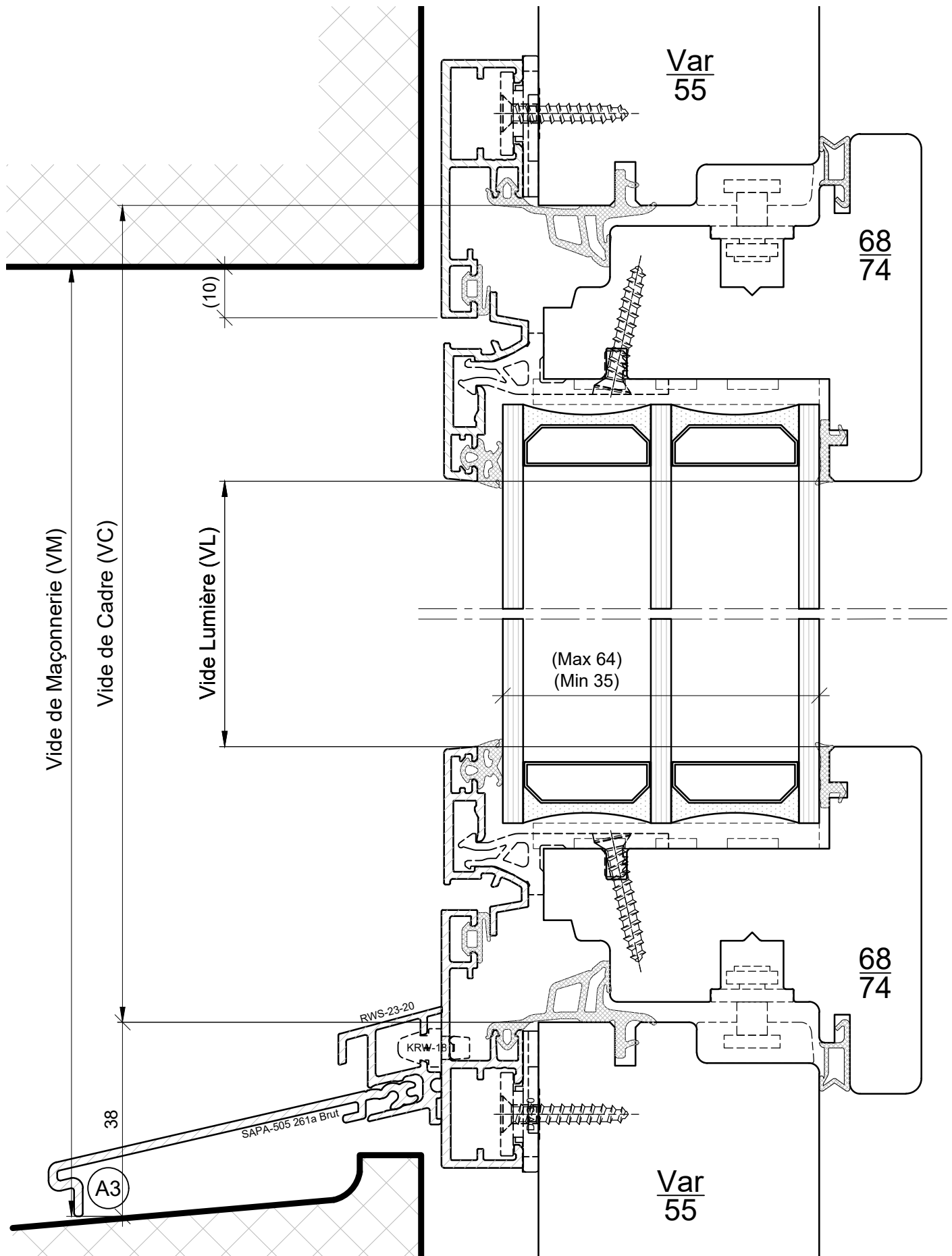

	SIFA-5574		Date: Visa d'approbation:
	Coupe Haut/Bas – Standard		
Echelle:	POSITION:	NBRE(S) DE PIECE(S):	
Date de création:	14-janv.-22	Sous réserve de modifications pour adaptation au progrès technique	
Date d'impression:	28-mars-22	c:\users\roland\Desktop\presentation clienta\alfa-5574 (ok)\alfa-5574	

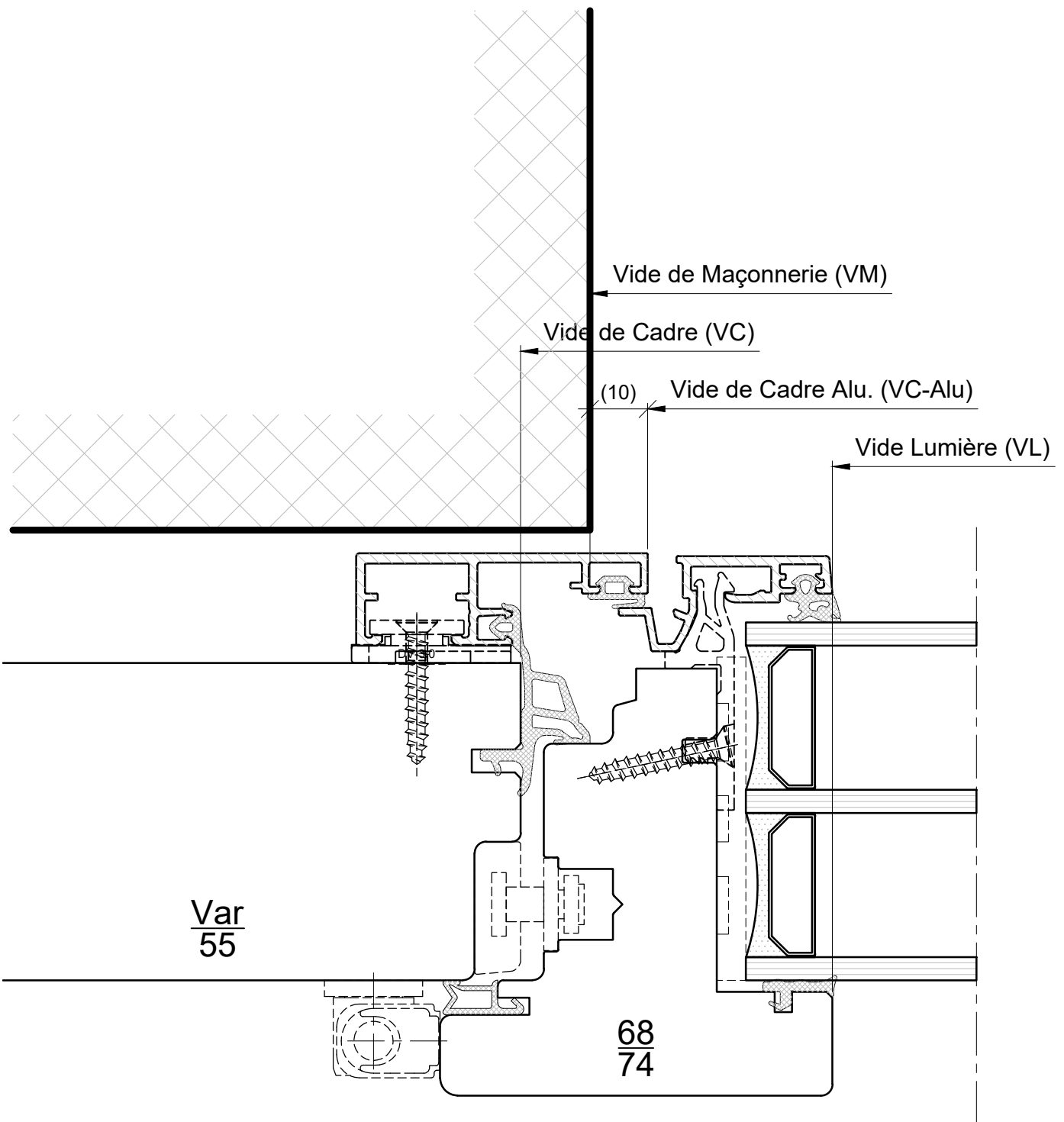

	SIFA-5574		
	Plan Latéral – Standard		
Echelle:	POSITION:	NBRE(S) DE PIECE(S):	
Date de création:	14-janv.-22	Sous réserve de modifications pour adaptation au progrès technique	
Date d'impression:	28-mars-22	c:\users\roland\Desktop\presentation client\alfa-5574 (ok)\alfa-5574	
			Date: Visa d'approbation:

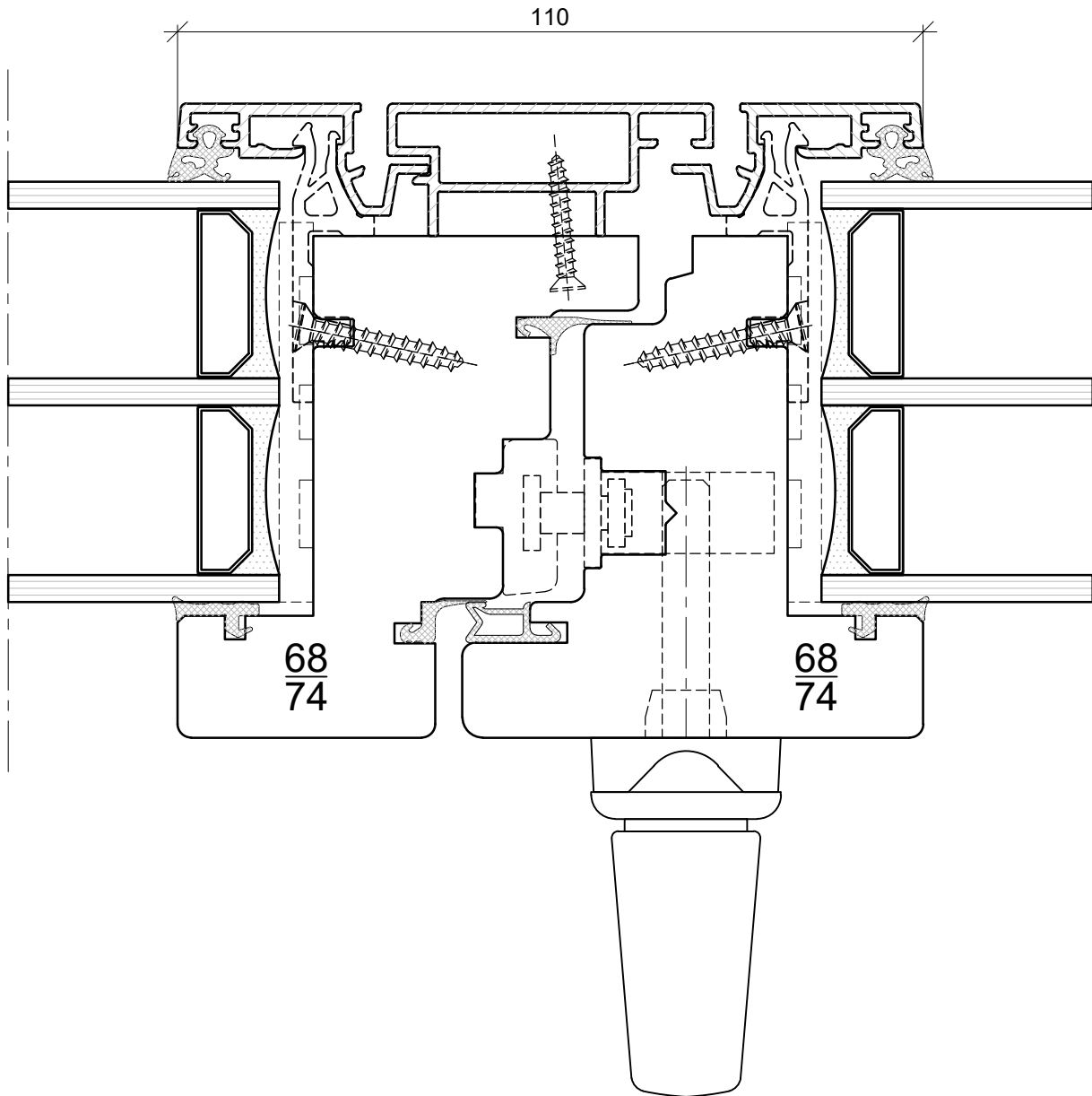

	SIFA-5574		
	Plan Médian – Standard		
Echelle:	POSITION:	NBRE(S) DE PIECE(S):	
Date de création:	14-janv.-22	Sous réserve de modifications pour adaptation au progrès technique	
Date d'impression:	28-mars-22	c:\users\roland\Desktop\presentation clienta\alfa-5574 (ok)\alfa-5574	
			Date: Visa d'approbation:

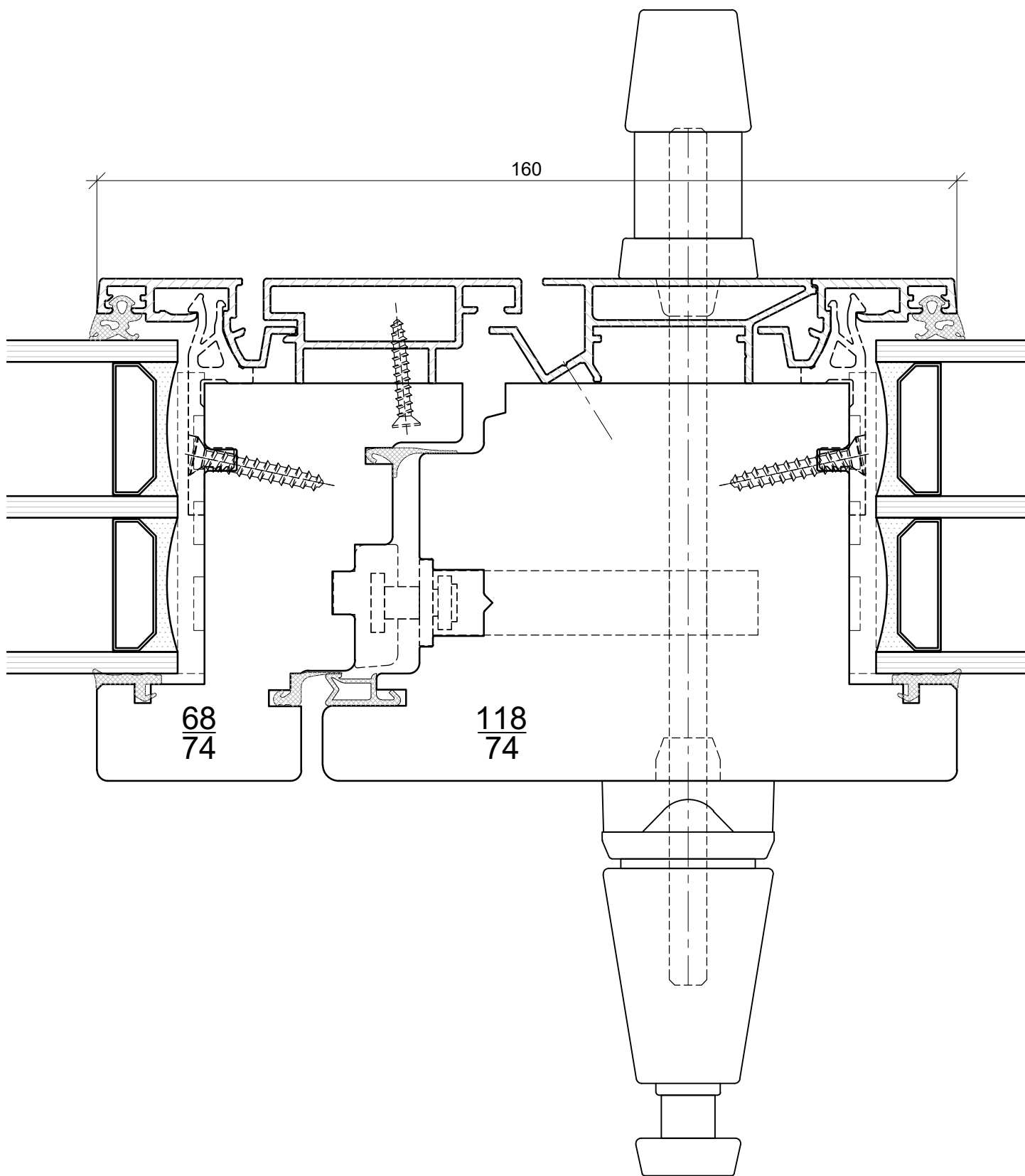

	SIFA-5574		
	Plan Médian – Poignée Traversante		
Echelle:	POSITION:	NBRE(S) DE PIECE(S):	
Date de création:	14-janv.-22	Sous réserve de modifications pour adaptation au progrès technique	
Date d'impression:	28-mars-22	c:\users\rolaino\Desktop\presentation clienta\alfa-5574 (ok)\alfa-5574	
			Date: Visa d'approbation:

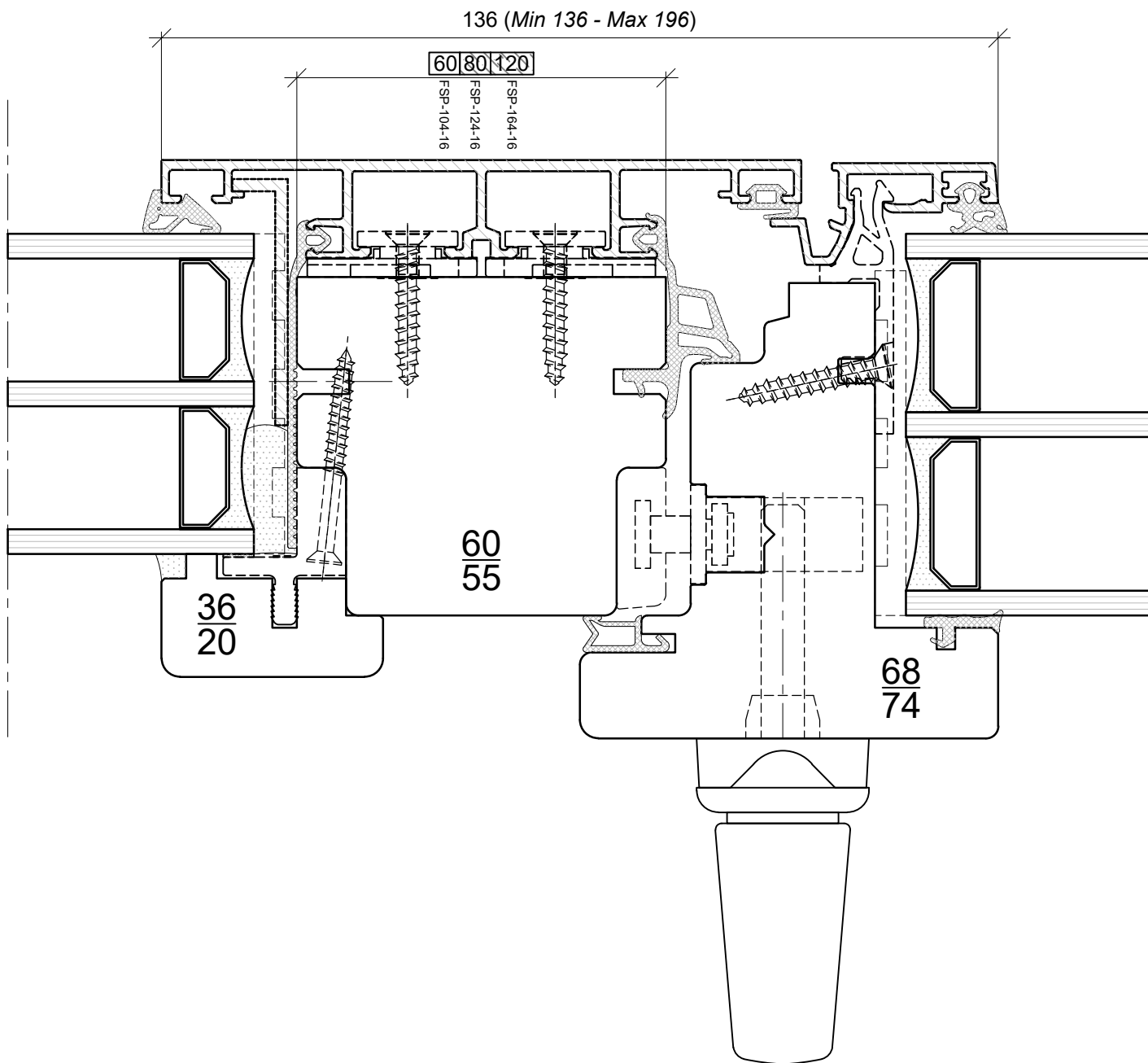

 Gindraux Fenêtres	SIFA-5574		
	Plan Médian – Fixe + Ouvrant		
Echelle:	POSITION:	NBRE(S) DE PIECE(S):	
Date de création:	14-janv.-22	Sous réserve de modifications pour adaptation au progrès technique	
Date d'impression:	28-mars-22	c:\users\rolaino\Desktop\presentation clienta\alfa-5574 (ok)\alfa-5574	
			Date: Visa d'approbation:

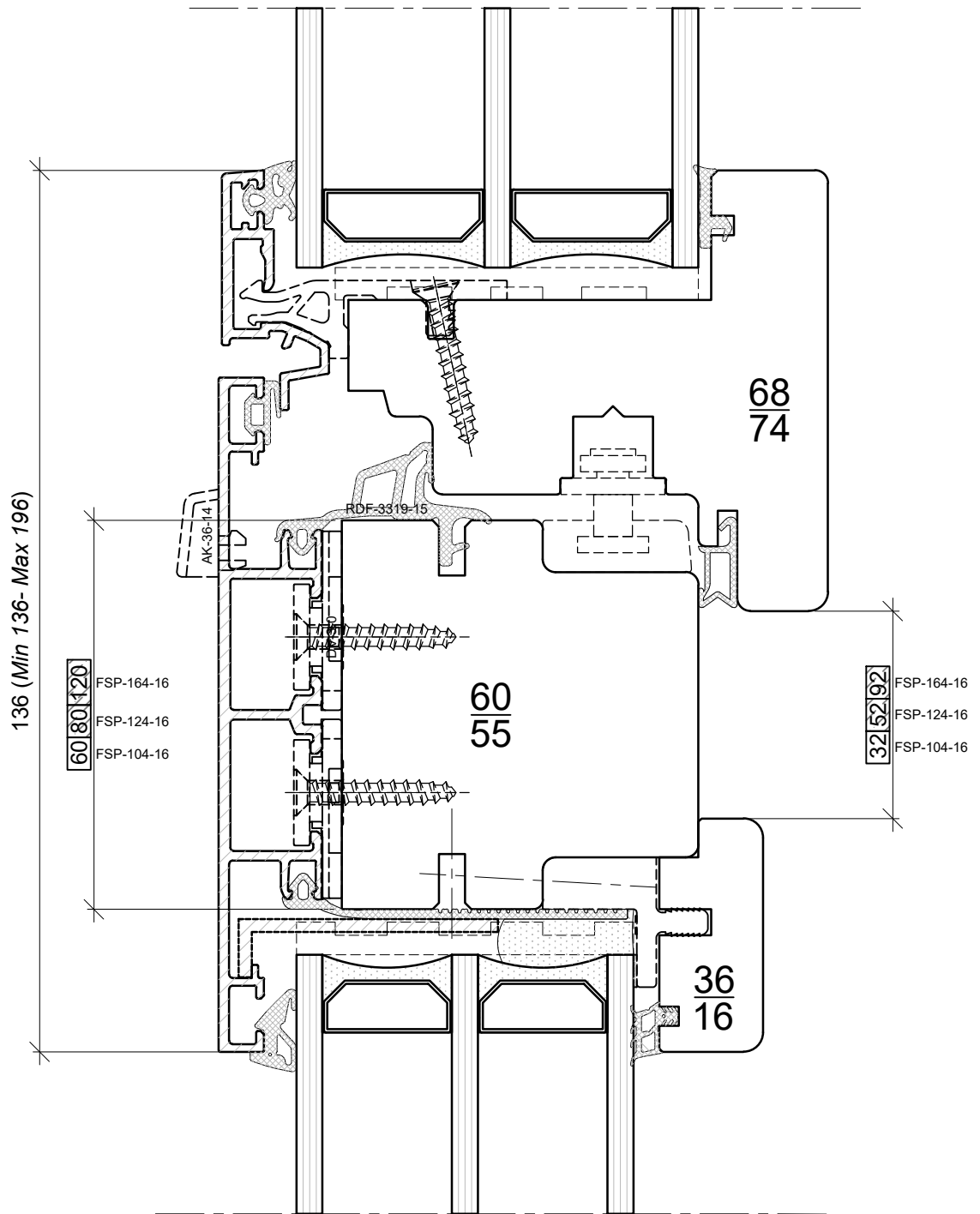

	SIFA-5574		
	Coupe Médiane – Fixe + Ouvrant		
Echelle:	POSITION:	NBRE(S) DE PIECE(S):	
Date de création:	14-janv.-22	Sous réserve de modifications pour adaptation au progrès technique	
Date d'impression:	28-mars-22	c:\users\rolaino\Desktop\presentation clienta\alfa-5574 (ok)\alfa-5574	
			Date: Visa d'approbation:

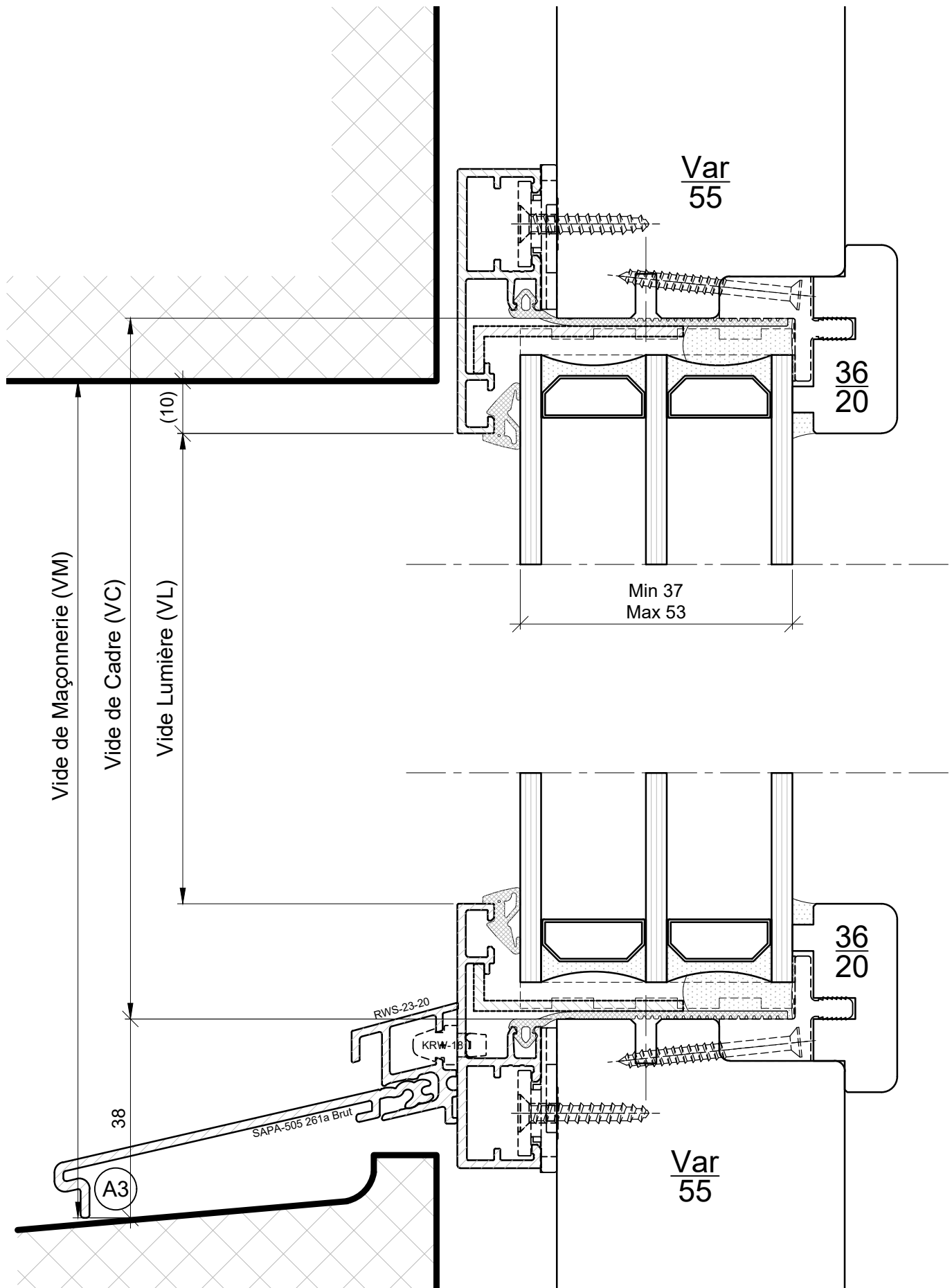

	SIFA-5574		Date: Visa d'approbation:
	Coupe Haut/Bas – Vitrage Fixe		
Echelle:	POSITION:	NBRE(S) DE PIECE(S):	
Date de création:	14-janv.-22	Sous réserve de modifications pour adaptation au progrès technique	
Date d'impression:	28-mars-22	c:\users\roland\Desktop\presentation clienta\alfa-5574 (ok)\alfa-5574	

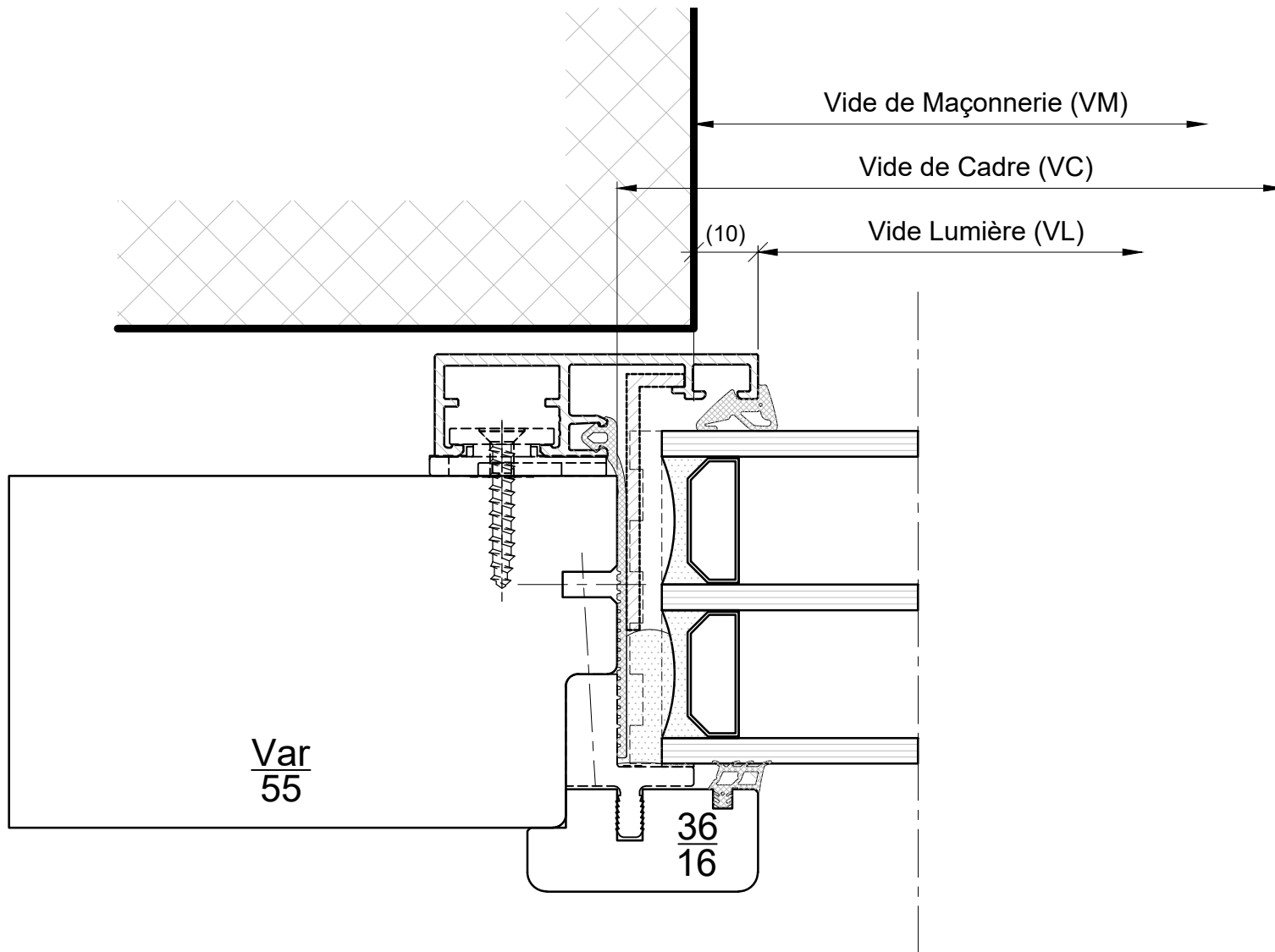

 Gindraux Fenêtres	SiFA-5574		Date: Visa d'approbation:
	Plan Latéral – Vitrage Fixe POSITION: NBRE(S) DE PIECE(S):		
Echelle:	14-janv.-22	Sous réserve de modifications pour adaptation au progrès technique	
Date de création:	28-mars-22	c:\users\valaino\Desktop\presentation clients\siifa-5574 (ok)\siifa-5574	

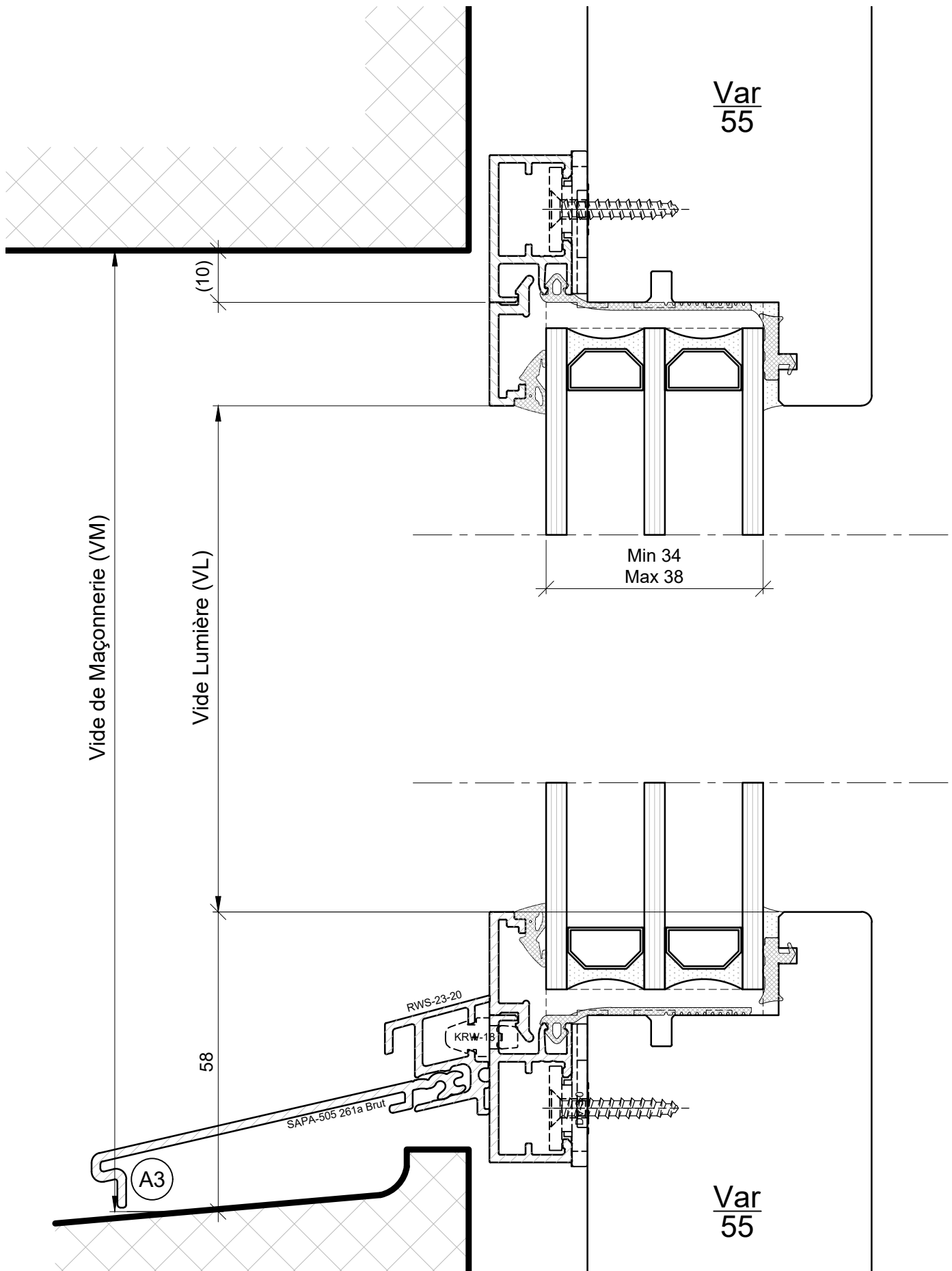

	SIFA-5574		Date: Visa d'approbation:
	Coupe Haut/Bas – Vitrage Extérieur		
Echelle:	POSITION:	NBRE(S) DE PIECE(S):	
Date de création:	14-janv.-22	Sous réserve de modifications pour adaptation au progrès technique	
Date d'impression:	28-mars-22	c:\users\roland\Desktop\presentation clienta\alfa-5574 (ok)\alfa-5574	

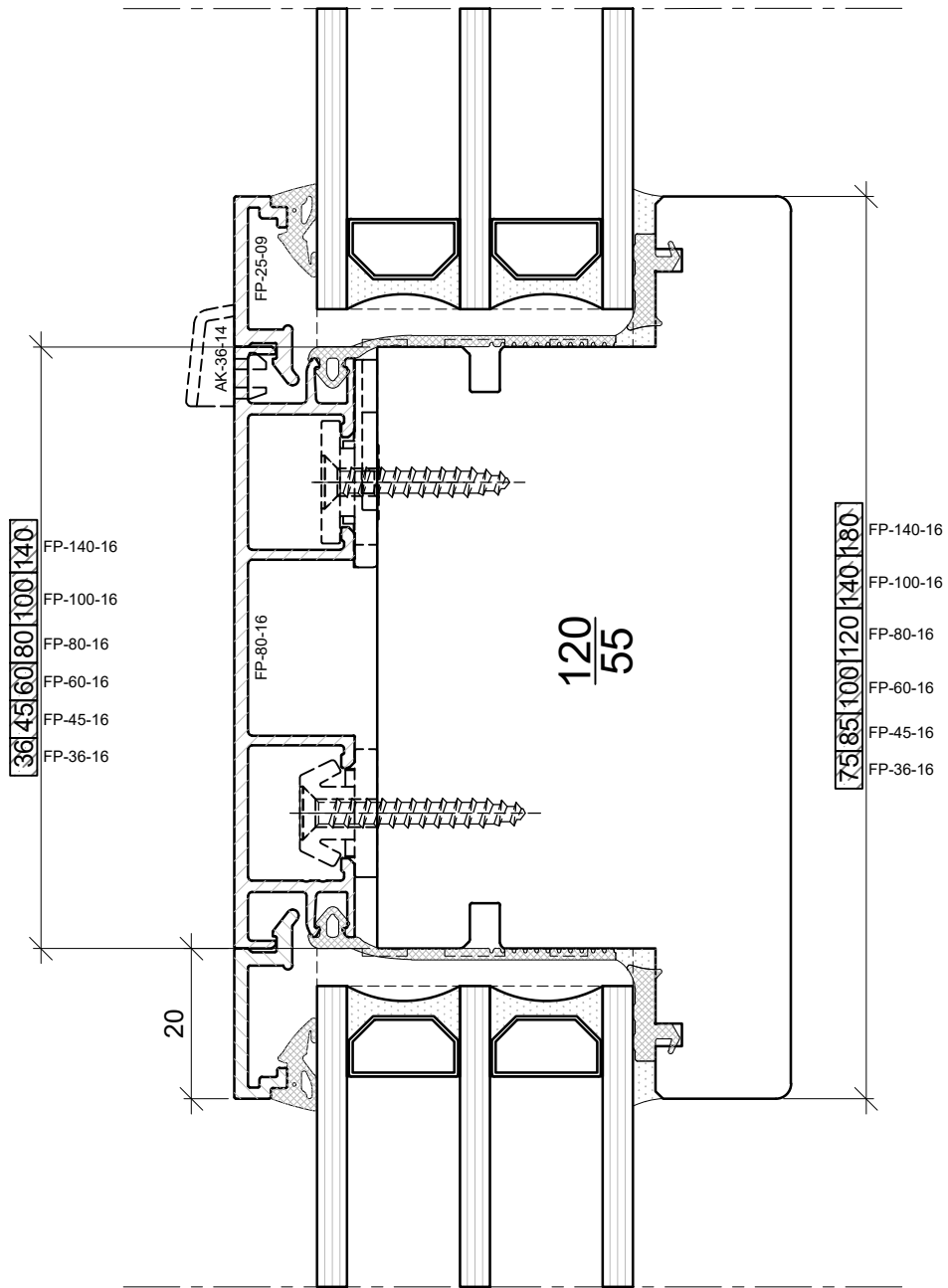

	SIFA-5574		
	Coupe Médiane – Vitrage Extérieur		
Echelle:	POSITION:	NBRE(S) DE PIECE(S):	
Date de création:	14-janv.-22	Sous réserve de modifications pour adaptation au progrès technique	
Date d'impression:	28-mars-22	c:\users\rolaino\Desktop\presentation clienta\alfa-5574 (ok)\alfa-5574	
			Date: Visa d'approbation:

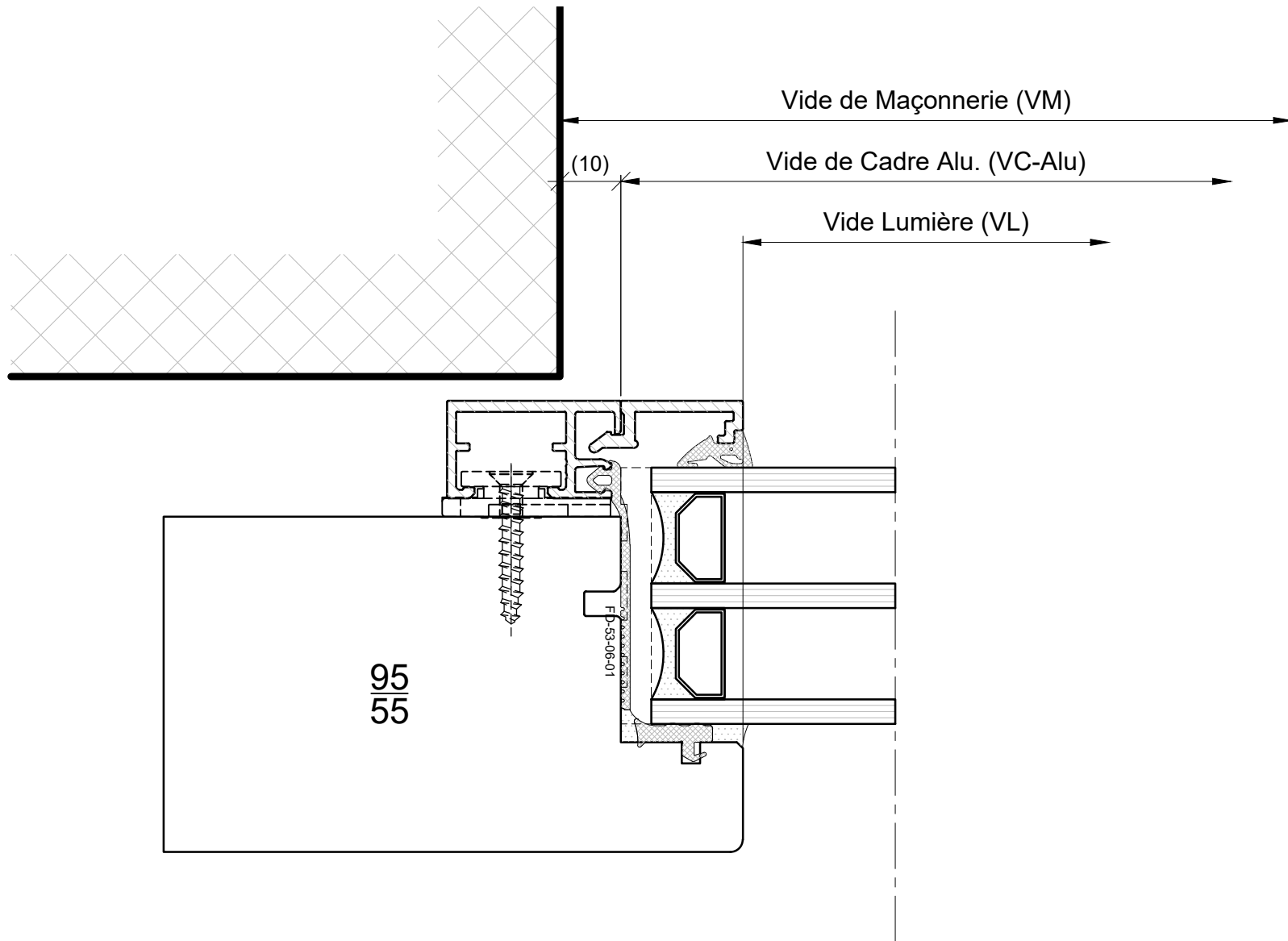

 Gindraux Fenêtres	SiFA-5574		Date: Visa d'approbation:
	Plan Latéral – Vitrage Extérieur POSITION: NBRE(S) DE PIECE(S):		
Echelle:	14-janv.-22	Sous réserve de modifications pour adaptation au progrès technique	
Date de création:	28-mars-22	c:\users\valaino\desktop\presentation clients\siifa-5574 (ok)\siifa-5574	